

# ALDUS ENERGIE HOLZ-ALU - Schnittzeichnungen

## FESTELEMENT

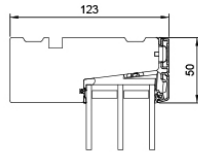

L6 Oberer Blendrahmen

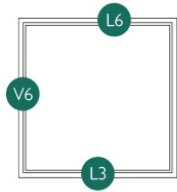
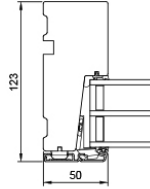

V6 Seitlicher Blendrahmen

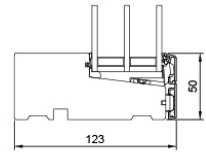

L3 Unterer Blendrahmen

## DREHFLÜGELFENSTER SEITENGESTEUERTES FENSTER/SEITENWENDEFENSTER AUSSTELLFENSTER

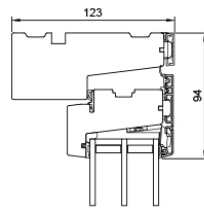
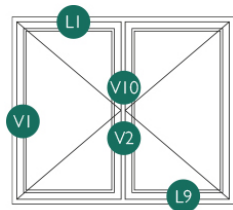

L1 Oberer Blendrahmen/  
Flügel

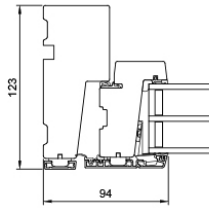

V1 Seitlicher Blendrahmen/  
Flügel

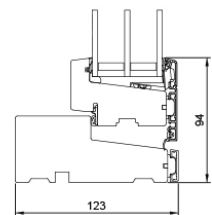

L9 Unterer Blendrahmen/  
Flügel

## TOPSCHWINGFENSTER

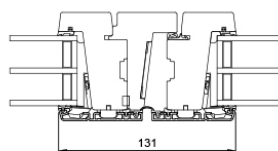
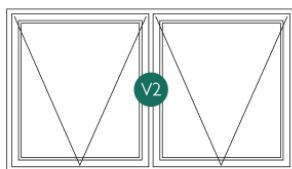

V10 Mittlerer Anschlag Stulp

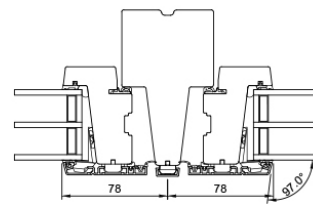

V2 A: Mittlerer Anschlag mit Pfosten  
B: Mittlerer Anschlag Topschwingfenster

## KOMBINATIONSELEMENTE

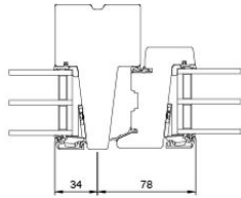
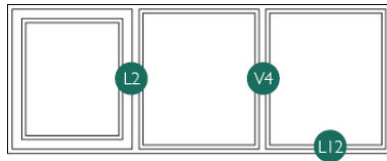

L2 Fester Blendrahmen/Flügel

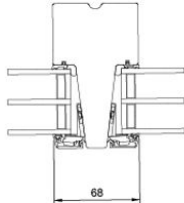

V4 Pfosten Fester Blendrahmen

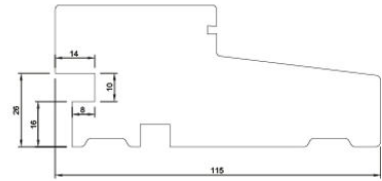

L12 Fensterbankfalz

## HAUSTÜR (EINWÄRTSÖFFNEND)

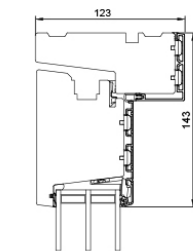
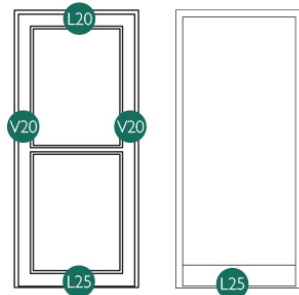

L20 Oberer Blendrahmen/Flügel

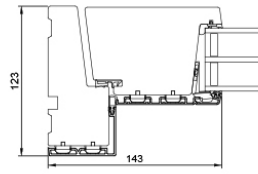

V20 Seitlicher Blendrahmen, Scharnierseite/Flügel

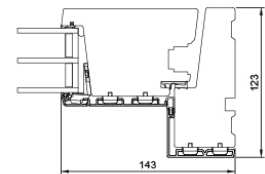

V20 Seitlicher Blendrahmen/Schließseite/Flügel

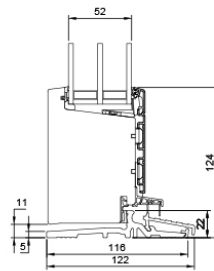

L25 Fußschwelle Standard

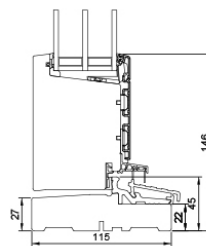

L25 Fußschwelle Holz – auf Wunsch, nur bei Rahmentüren

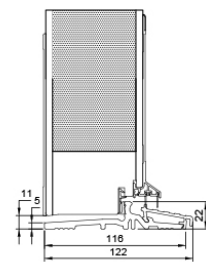

L25 Fußschwelle Standard bei Plattentüren

## HAUSTÜR MIT INTEGRIERTEM SEITENTEIL UND OBERLICHT (AUSWÄRTSÖFFNEND)

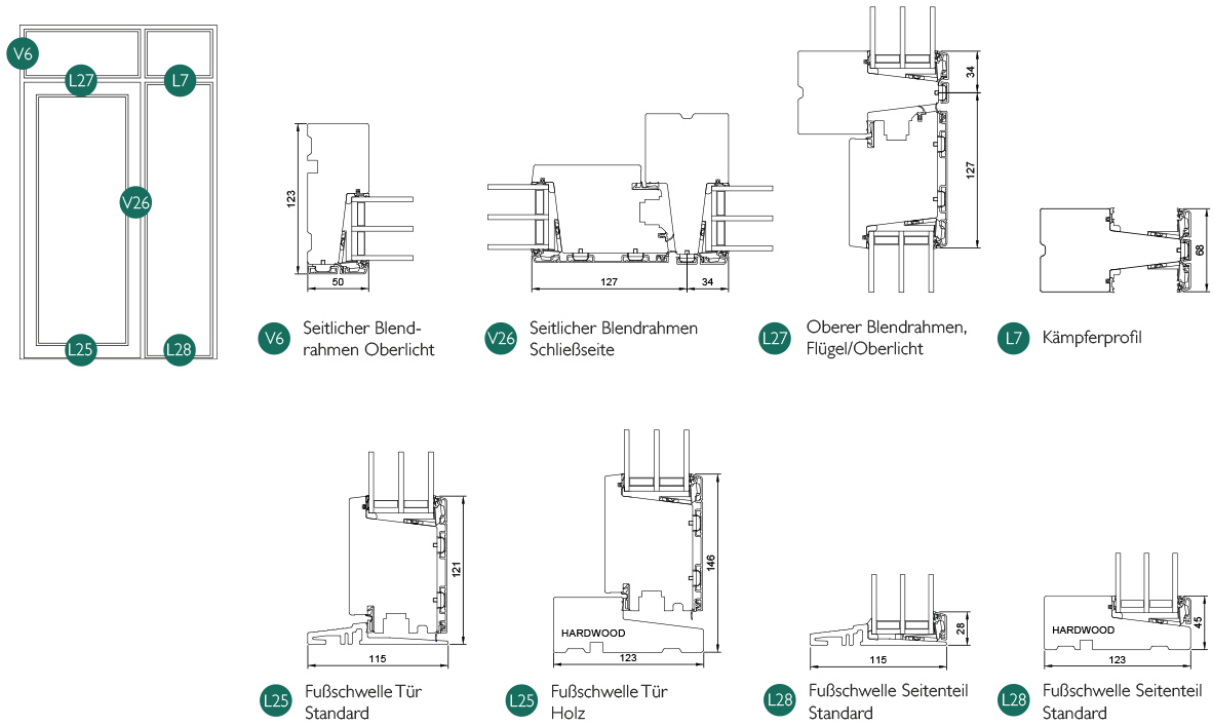

## HAUSTÜR MIT INTEGRIERTEM SEITENTEIL UND OBERLICHT (EINWÄRTSÖFFNEND)

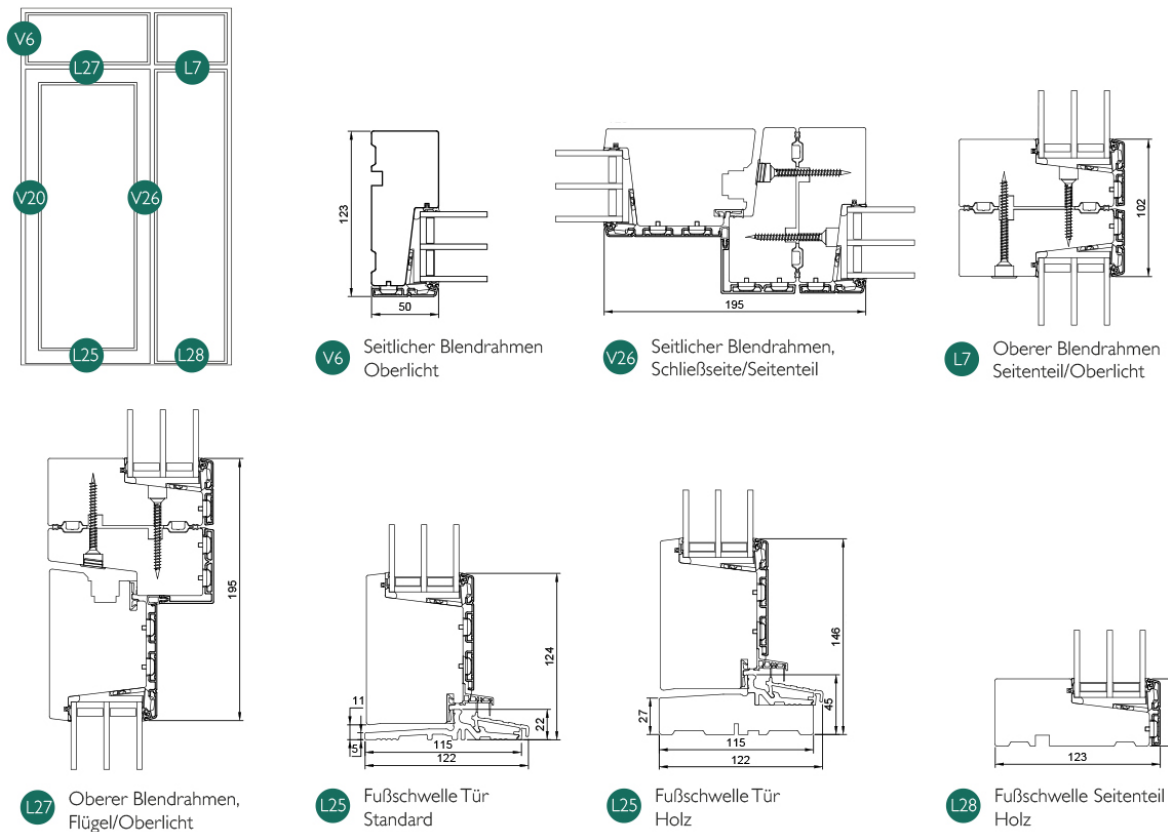

## TERRASSENTÜR/HAUSTÜR (AUSWÄRTSÖFFNEND)

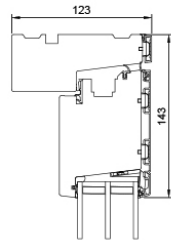
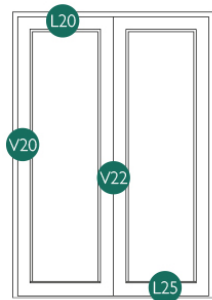

**L20** Oberer Blendrahmen/  
Flügel

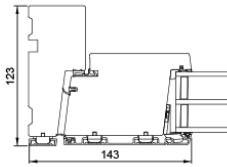

**V20** Seitlicher Blendrahmen/  
Flügel

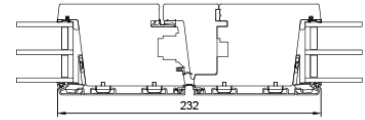

**V22** Stulpausführung

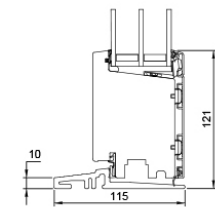

**L25** Fußschwelle  
Standard

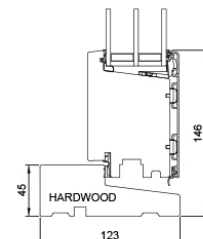

**L25** Fußschwelle  
Holz

## FENSTERTÜR (AUSWÄRTSÖFFNEND)

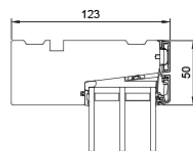
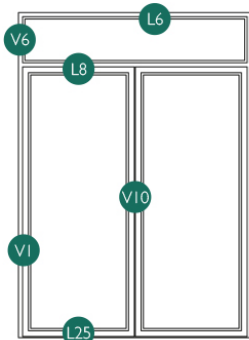

**L6** Oberer Blendrahmen  
Oberlicht

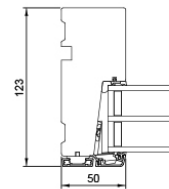

**V6** Seitlicher Blendrahmen  
Oberlicht

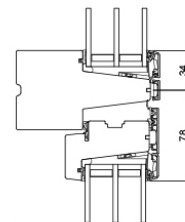

**L8** Kämpfer, Flügel/  
Oberlicht

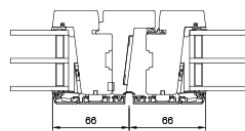

**V10** Mittlerer Anschlag Stulp

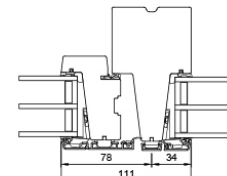

**V11** Seitlicher Blendrahmen/  
Seitenteil

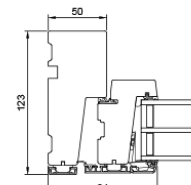

**V1** Seitlicher Blendrahmen/  
Flügel

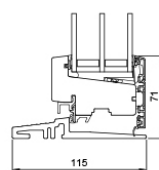
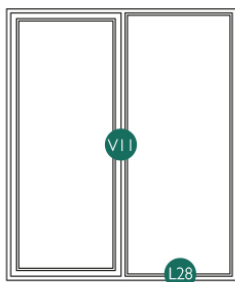

**L25** Fußschwelle Tür  
Standard

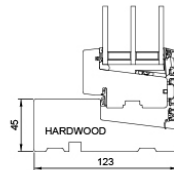

**L25** Fußschwelle Tür  
Holz

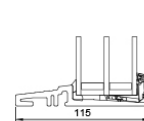

**L28** Fußschwelle Seitenteil  
Standard

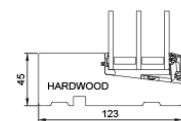

**L28** Fußschwelle Seitenteil  
Holz

## VENTILIERTE FÜLLUNG

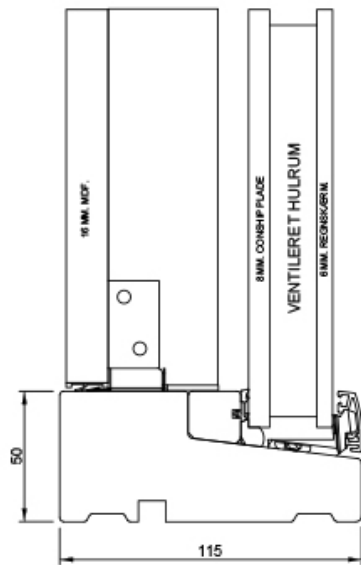

● Ventilerte Füllung  
unterer Blendrahmen

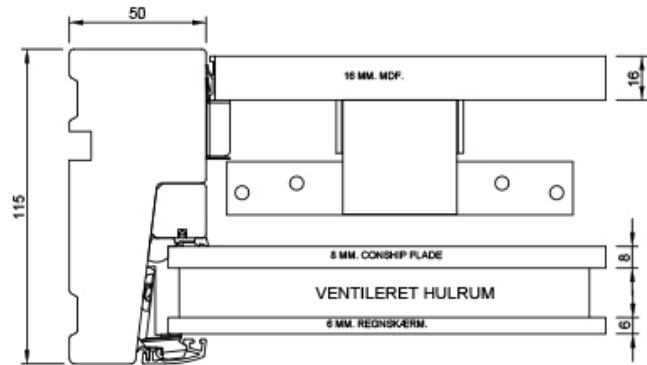

● Ventilerte Füllung  
seitlicher Blendrahmen

## BLENDRAHMENTIEFEN (STANDARD)

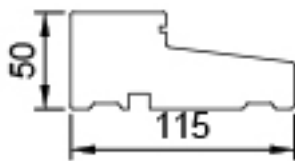
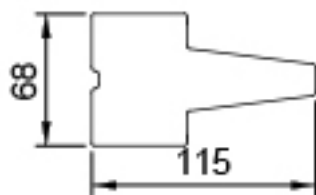

## EXTRA TIEF

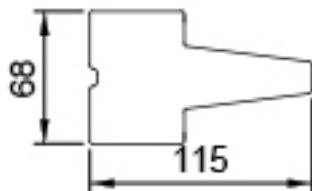

## SPROSSE

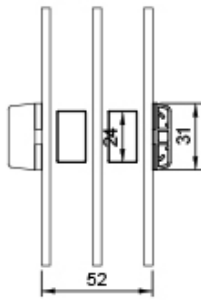

31 mm Sprosse

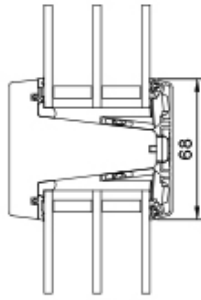

68 mm Sprosse

## HEBESCHIEBETÜR

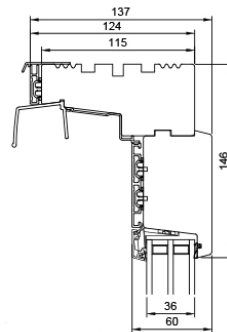
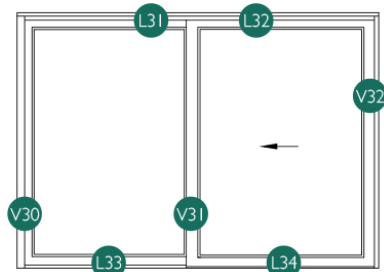

L31 Oberer Blendrahmen fester Teil

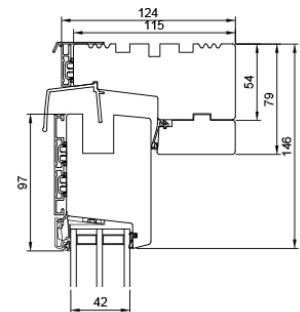

L32 Oberer Blendrahmen mit Flügel

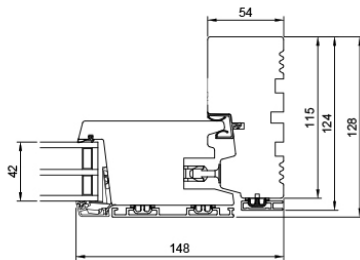

V32 Seitlicher Blendrahmen/Flügel

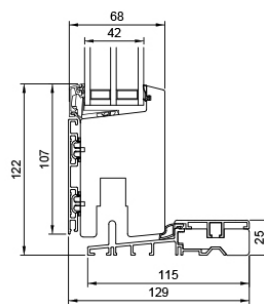

L34 Fußschwelle beweglicher Teil

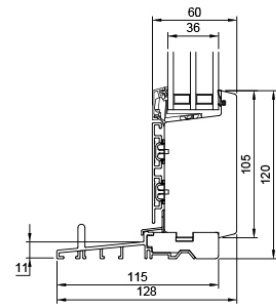

L33 Fußschwelle fester Teil

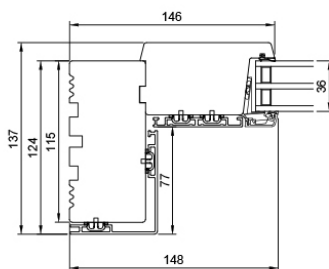

V30 Seitlicher Blendrahmen fester Teil

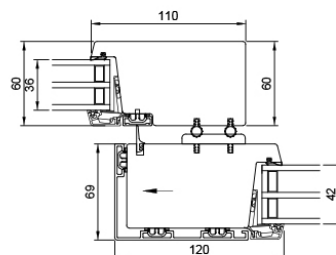

V31 Mittelposten/Flügel

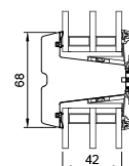

Sprosse

## DREH-KIPP-FENSTER

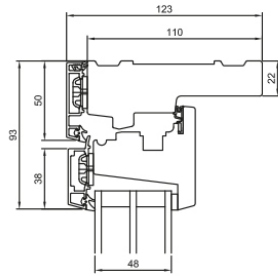
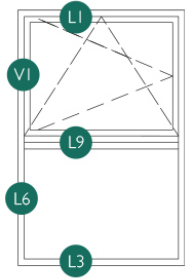

**L1** Oberer Blendrahmen/Flügel

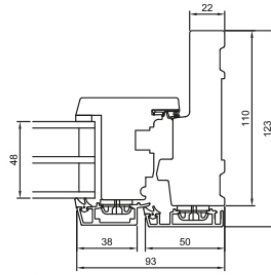

**V1** Seitlicher Blendrahmen/Flügel

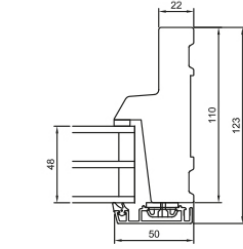

**L6** Seitlicher Blendrahmen Unterlicht

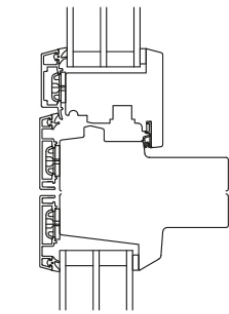

**L9** Kämpferprofil Flügel/Festelement

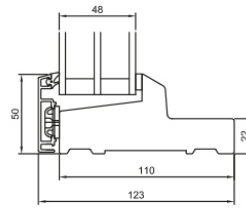

**L3** Fußschwelle Unterlicht

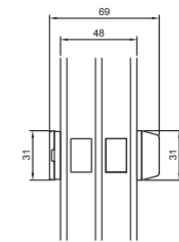

**31 mm Sprosse**

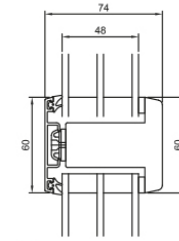

**60 mm Sprosse**

## DREH-KIPP-TÜR

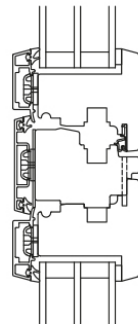
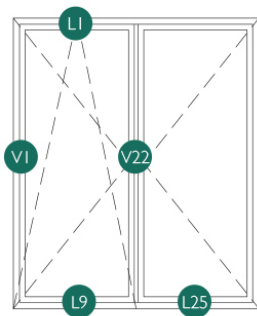

**V22** Stulpausführung

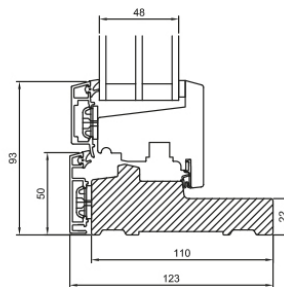

**L25** Fußschwelle  
Hartholz

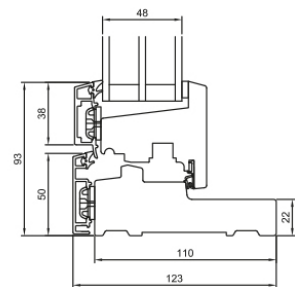

**L25** Fußschwelle  
Holz